

A Practical Approach to Available Bandwidth Estimation Techniques (ABETs) for an Efficient Telemedicine Content Transport Network

Daniel Sinkonde Kayange, Ramadhani Sinde, Anael Sam, Elisha Oketch Ochola

Abstract— The ability to measure end-to-end Available Bandwidth (unused capacity) in the network path is useful for route selection in overlay networks, QoS verification, network management, traffic engineering and real-time resource provisioning, control flow and congestion, construction of overlay - routing infrastructure, topology building in peer to peer networks, and call admission control, dynamic encoding rate modification in streaming applications, capacity planning, intelligent routing systems, and design of transport layer protocols. This paper investigates at applying a practical approach techniques for a measurement of Available Bandwidth (AB) in the congestion control for the transmission of an efficient telemedicine content transport network by using an important ABETs tool such as IGI and PTR. This paper discusses measurement and simulation results of wired and wireless networks for the unused capacity in the network. The results can assist an organization or country in estimating the network bandwidth requirements depending on the ability of exchange multimedia data of an organization or country. The logistics could cater implementation of low cost telemedicine applications. The telemedicine systems could include wireless and wired medical interface and communication infrastructure. A simulation has been done to investigate the network quality of service.

Index Terms— Available Bandwidth, Measurement, Quality of Service, Probing, Packet Pairs, Networks, Telemedicine

1 INTRODUCTION

THE packet pair mechanism has been shown to be a reliable method to measure the bottleneck link capacity on a network path, but its use for measuring available bandwidth is more challenging. In this paper, we use measurements and simulations to better characterize the interaction between probing packets and the competing network traffic for wired network and wireless network and application of bandwidth estimation for medical practice. We first construct a simple model to understand how competing traffic changes the probing packet gap for a single-hop network. The gap model shows that the initial probing gap is a critical parameter when using packet pairs to estimate available bandwidth. Based on this insight, we present two available bandwidth measurement techniques, the initial gap increasing (IGI) method and the packet transmission rate (PTR) method. We use extensive Internet measurements to show that these techniques estimate available bandwidth in wired networks and wireless networks.

Finally, using both Internet measurements and MATLAB

R2012b simulations, to explore how the measurement between wired networks and wireless networks differs, depending on that result an organization or country could estimate the network bandwidth requirements depending on the ability of exchange multimedia data of an organization or country.

The main objective of communication system design is to ensure the message signal is delivered efficiently and reliably subject to the following constraints: allowable transmit power, available channel bandwidth, and affordable cost of building the system. Further, in an over- lay, one can assume the cooperation of both the sender and the receiver, which is necessary for most probing techniques.

Many available bandwidth estimation tools have emerged such as IGI/PTR [1] Pathload [2], and Pathchirp [3].

1.1 Definition and overview of ABE techniques

The available bandwidth (ABE) at a link is its unused capacity. Since, at any time, a link is either idle or transmitting packets at the maximum speed, the definition of the available bandwidth ought to look at the average unused bandwidth over some time interval T . Thus,

$$A_i(t, T) = \frac{1}{T} \int_t^{T+t} (C_i - \lambda_i(t)) dt,$$

Where $A_i(t, T)$ is the available bandwidth at link i at time t , c_i is the link's capacity, and λ_i is its traffic. The available bandwidth along a path is the minimum available bandwidth of all traversed links [4].

- Daniel Sinkonde Kayange is currently pursuing masters degree program in Information Communication Science and Engineering in Nelson Mandela African Institute of Science and Technology- NM - AIST -Arusha , Tanzania, PH+255 754 952 280. E-mail: kayanged@nm-aist.ac.tz
- Dr. Anael Sam senior Lecturer, Nelson Mandela African Institute of Science and Technology- NM - AIST -Arusha, Tanzania, E-mail: anael.sam@nm-aist.ac.tz.
- Mr. Ramadhani Sinde Assistant Lecturer, Nelson Mandela African Institute of Science and Technology- NM - AIST -Arusha , Tanzania, E-mail: ramadhani.sinde@nm-aist.ac.tz
- Elisha Oketch Ochola, School of Computing, University of South Africa, Pretoria, South Africa. E-mail: ocholeo@unisa.ac.za

1.2 Bandwidth is Expensive

Bandwidth is a scarce resource. Bandwidth is also expensive due to the comparative weakness of the currencies of developing countries that have to pay in US dollars, Euros or other major currencies for most or all of their upstream international bandwidth. While the cost of the telecommunications link between two countries is generally shared, in the case of African countries (and possibly of many other developing countries) the cost of the international link is paid for entirely by the African country. This amounts to reverse subsidization of developed countries. The wired telecommunications networks in many developing countries reach only a small part of the population, and many areas (even parts of cities) are not covered at all. The development of wired networks cannot follow the same course as it did in industrialized countries owing to small populations or low population densities in some areas, poverty, the rise of mobile use and satellite communications. Furthermore, data transmission over the air is currently monetarily expensive [5].

1.3 Why Telemedicine

Telemedicine promises an improvement of health care service quality in rural, urban, dense and high mobile areas by reducing cost, optimizing communication resources utilization, providing medical expertise from a distance and addressing lack laboratory / x-rays expertise. In order to implement the telemedicine in these areas, a low cost telemedicine system with acceptable quality for medical data transfer is required [6].

This paper is organized as follows. We first discuss the related work in Section 2. In Section 3, we introduce Experimental setup for the IGI and PTR. In Section 4, we present our application of ABETs in end to end telemedicine services. In section 5, we present how ICTs bring about development. We conclude in Section VI.

2 RELATED WORK

Much work has been done in the bandwidth estimation area during the recent years. The problem of estimating the bottleneck link bandwidth using active probing is well studied. The work in [7] classifies the tools into single packet methods and packet pair methods. In this section the emphasis is on state-of-the-art bandwidth measurement, measurements in wired networks and wireless networks and applications of bandwidth estimation for medical interface. Examples of probing tools which have emerged in recent years are Pathload[2], IGI/PTR [1], Abing [8], Spruce [4], PathChirp [3], DietTopp[9], Yaz [10], and ASSOLO. Single packet tools include pathchar [11], clink [12], and pchar [13]. These methods differ in size and temporal structure of probe streams, and in the way the available bandwidth is derived from the received packets [14]. There are different approaches to estimate the available bandwidth in an end-to-end Path: the probe gap model (e.g. Spruce, IGI) and the probe rate model (e.g. Pathload, PathChirp). PGM observes probing packet pair dispersions while PRM observes one way

delays (OWD) in the probing packets. Both the PGM and PRM approaches utilize a train of probing packets to generate an averaged estimation and cope in that way with the burstiness nature of cross traffic.

2.1 Rate Model

The rate model (self-induced congestion) is based on the following heuristic argument: If the rate of a probing stream exceeds the path from the sender to the receiver, short term congestion happens at the tight link (i.e. the link with the smallest ABW). A queue builds up on the tight link with the interleaving of probe packets and cross traffic packets.

2.2 Gap Model

The gap model has several assumptions. (1) Cross traffic is of a fluid type. (2) FIFO queuing at all routers along the path. (3) The narrow link and the tight link are identical. (4) Packets must be queued together before being transmitted to the narrow link. (5) Accurate timing is needed to compute the packet gaps.

2.3 The probe gap model (PGM)

This model bases the exploits of the information in the time gap between the arrivals of two successive probes at the receiver. A probe pair is sent with a time gap Δ_{in} , and reaches the receiver with a time gap Δ_{out} . Assuming a single bottleneck and that the queue does not become empty between the departure of the first probe in the pair and the arrival of the second probe, then Δ_{out} is the time taken by the bottleneck to transmit the second probe in the pair and the cross traffic that arrived during Δ_{in} , as shown in Figure 1 below. Thus, the time to transmit the cross traffic is $\Delta_{out} - \Delta_{in}$, and the rate of the cross-traffic is $\frac{\Delta_{out} - \Delta_{in}}{\Delta_{in}} \times C$, where C is the capacity of the bottleneck. The available bandwidth is:

$$A = C \times \left(1 - \frac{\Delta_{out} - \Delta_{in}}{\Delta_{in}}\right) = C \times \frac{\Delta_{in}}{\Delta_{out}}$$

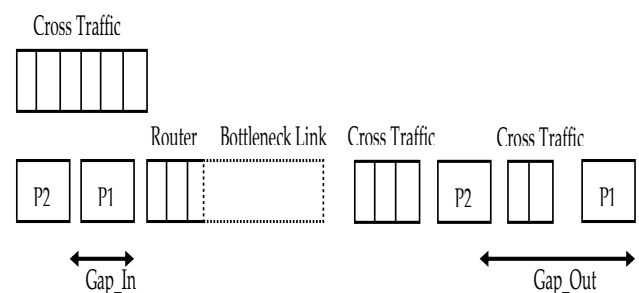

Figure 1. Packet pair probe gap model [1]

2.4 The probe rate model (PRM)

This is a model based on the concept of self-induced congestion, in which the tools send probe packet trains at increasing rates and the receiver observes variations in the average train one way delay looking for the turning point, or the point at which the delay of the probe packets starts increasing in a consistent basis. If one sends probe traffic at a rate lower than the available bandwidth along the path, then

the arrival rate of probe traffic at the receiver will match their rate at the sender. In contrast, if the probe traffic is sent at a rate higher than the available bandwidth, then queues will build up inside the network and the probe traffic will be delayed. The available bandwidth is then estimated looking at the probe packet rate utilized when the turning point is found. At this point, the train rate is equal to the available bandwidth in the end-to-end path.

Examples of tools in the probe rate model are Pathload [2] and Pathchirp [3]

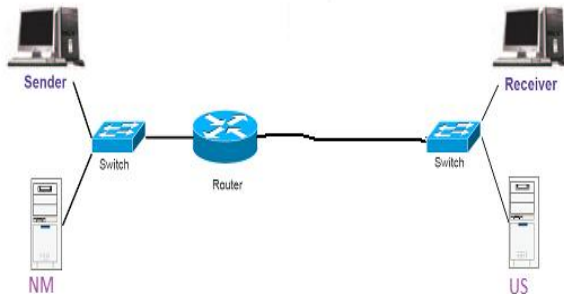

Figure 2. Architecture of IGI/PTR

IGI [1] a series of packet trains is sent from the source to the destination with increasing initial gaps. The inter packet gap in a packet pair is measured at the source and at the destination and the distinction in the inter packet gaps is used to estimate the available bandwidth in the network. The bottleneck link rate is a direct measure of the spacing between the packets and links with higher available bandwidths maintain the spacing between the packets. Available bandwidth in a network is a dynamic metric that can change instantaneously and so a mean of samples measured over a period of time will be representative of the true available bandwidth. So IGI uses a train of packet pairs instead of just a packet pair to estimate the available bandwidth.

The final measurements,

1. Units: Mbps (Mega bits/Second)
2. Bottleneck Bandwidth: the bottleneck link capacity
3. Competing Bandwidth: the throughput of background traffic for "IGI" algorithm
4. Packet Transmit Rate: the "PTR" value, the probing rate of the packet train at the turning point
5. Available Bandwidth: Competing Bandwidth, this is so called "IGI" value - Bottleneck Bandwidth

When a pair of probing packets is sent, the competing cross traffic along the path introduces delays in the packet spacing and so is proportional to the packet spacing as seen in Figure.2. The above statement is true only in the scenario where the second packet arrives in the queue before the first packet leaves the queue. In this scenario the output gap is the sum of the time to process the first packet and the time to process the competing cross traffic at the bottleneck link. The initial gap between the probing packets has a significant effect on the IGI/PTR algorithms.

These techniques are used to experimentally determine the initial gap (D_{in}) that will yield a high correlation between the competing traffic throughput on the tight link and the output gap (D_{out}) at the destination. IGI finds an initial probing gap value so that a probing packet train interacts with the cross traffic in a non empty narrow link queue, which is called by the authors the Joint Queuing Region (JQR). In that region, there is a proportional relation between the gap when probing packets leave the queue (output gap) and the cross traffic. The authors find two components in the mathematical definition of the output gap under this JQR region:

$$\Delta_{out} = gB + \frac{B_c \Delta_{in}}{C_t}$$

Besides the initial gap, two other parameters also affect the accuracy of the IGI and PTR algorithms.

Probing packet size: Measurements using small probing packets are very sensitive to interference. The work in [15] also points out significant post-bottleneck effects for small packets. This argues for sending larger probing packets.

The number of probing packets: It is well known that the Internet traffic is bursty, so a short snapshot cannot capture the average traffic load. That argues for sending a fairly large number of probing packets. However, sending too many packets can cause queue overflow and packet losses, increase the load on the network, and lengthen the time it takes to get an estimate.

3 EXPERIMENTAL SETUP

The performance of the experiment of measurement and estimation is performed in a network testbed with Poisson, burst and self-similar synthetic cross traffic and in a real network path at the Nelson Mandela African Institute of Science and Technology [16].

3.1 Experiments

Using the testbed, the tools analyzed under this evaluation approach is IGI and PTR according to their estimation time, size of packets, number of packets per train and number of packet trains on the accuracy, convergence time and the intrusiveness of the tools under wireless bandwidth and wired bandwidth scenarios. The estimation time in the case of IGI and PTR is provided directly by the tool.

Three main cases were studied. In the first phase, the tools are evaluated in a wired bandwidth environment. The second phase the tools evaluates in wireless bandwidth network conditions. The last phase evaluates the tools under variable load conditions [17].

3.2 Measurement results in wired bandwidth networks environment

This section presents measurements done with IGI and PTR in all wired scenario. The measurements have been performed in a testbed containing wired hops. Our testbed topology only consists of 140 wired hops, but we believe that our results illustrate the measurement problem for larger ad-hoc networks, consisting of several wired hops, as well.

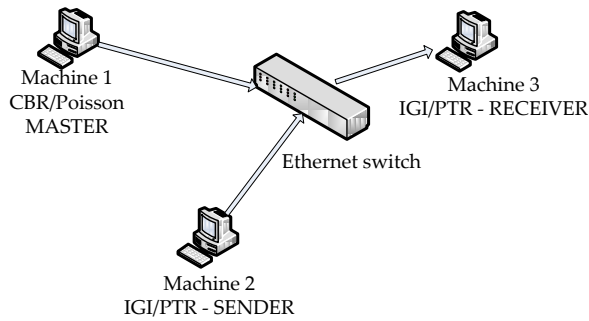

Figure 3 Testbed setup at the Nelson Mandela African Institute of Science and Technology.

The diagram in Figure 4 and Figure 5 illustrates results from IGI and PTR measurements in wired scenarios. We now compare IGI with PTR using a simple test bed at the University of Nelson Mandela African Institute of Science and Technology depicted in Fig. 3. The goal is to compare their efficiency in terms of number of bytes used to obtain available bandwidth estimates of equal accuracy.

The IGI and PTR, we use both IGI and PTR algorithms to estimate the available bandwidth. The probing packet size is set to 500 Byte and the probing packet number is 60. So far our measurements have shown that the two techniques algorithms have similar accuracy in terms of predicting available bandwidth. However, the IGI and PTR methods have the same measurement time.

The packet train length has a large impact on the cost of the PTR and IGI algorithms, since it affects both the number of packets that are sent. Naturally, shorter packet trains provide less accurate information, so more phases may be needed to converge on the turning point.

We performed twenty four experiments for each tool. Both cross-traffic streams are exponentially distributed. The y-axis shows the measured Available bandwidth in Mbps, while the x-axis shows the twenty four hours experiments are carried out for each tool

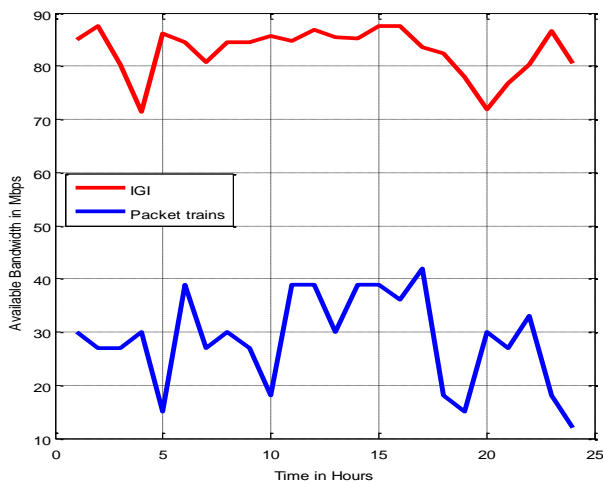

Figure 4. Testbed experiment using IGI in wired networks

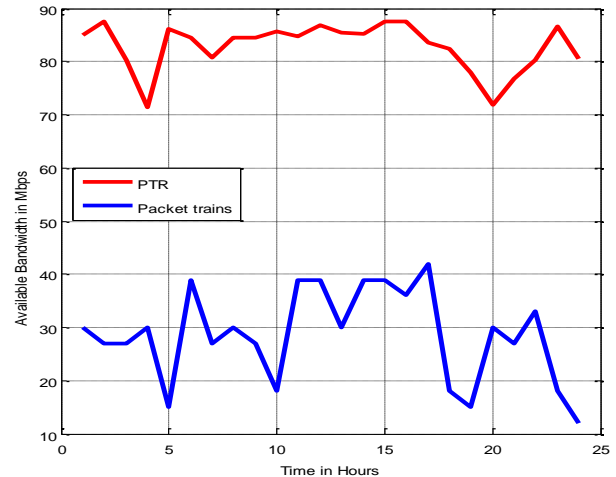

Figure 5. PTR measurements in wired accuracy on testbed

3.3 Measurement results in wireless bandwidth networks environment

This subsection presents our results from measurements using IGI and PTR where the bottleneck is a wireless link in the testbed as described in figure 3, which is the case in ad-hoc wireless networks. The measurements have been performed in a testbed containing wireless hops. Our testbed topology only consists of 140 wireless hops, but we believe that our results illustrate the measurement problem for larger ad-hoc networks, consisting of several wireless hops, as well.

Figures 6 and 7 present the available bandwidth estimation (unused capacity in the real network path) for wireless measurement and the result obtained from the simulation experiments of IGI and PTR with respect to time. We compare IGI and PTR using a simple test bed at the University of Nelson Mandela African Institute of Science and Technology depicted in Fig. 3.

The IGI and PTR, we use both IGI and PTR algorithms to estimate the available bandwidth. The probing packet size is set to 500 Byte packet sizes and the probing packet number is 60. Therefore our measurements have shown that the two techniques algorithms have similar accuracy in terms of predicting available bandwidth. However, the IGI and PTR methods have the same measurement time.

The packet train length has a large impact on the cost of the PTR and IGI algorithms, since it affects both the number of packets that are sent. Naturally, shorter packet trains provide less accurate information, so more phases may be needed to converge on the turning point.

We perform twenty four experiments for each tool. Both cross-traffic streams are exponentially distributed. The y-axis shows the measured Available bandwidth in Mbps, while the x-axis shows the twenty four hours experiments are carried out for each tool

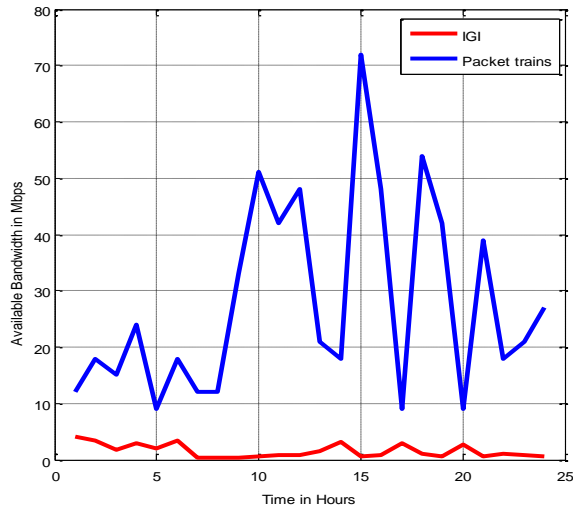

Figure 6. IGI measurement in wireless accuracy on testbed

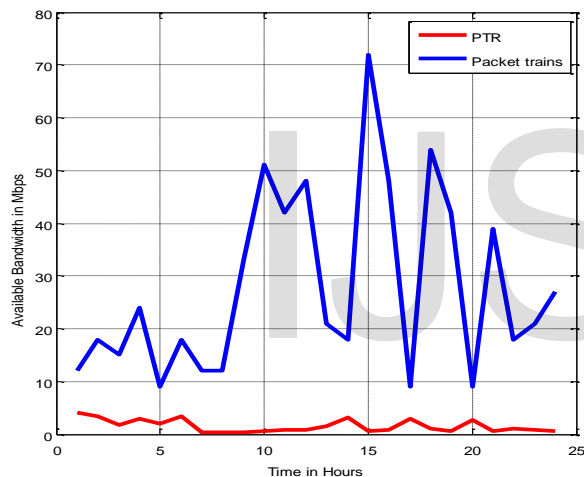

Figure 7. Testbed experiment using PTR in Wireless networks

3.4 Measurement results in wireless networks

Measurements in wireless networks are associated with frequent disconnections, predictable disconnections, physical support for broadcast, asymmetry, monetarily expensive, relatively unreliable, high bandwidth variability, low bandwidth. These are the difficulties that can result in misleading bandwidth estimations for medical practice.

4 APPLICATIONS OF BANDWIDTH MEASUREMENTS IN END TO END TELEMEDICINE SERVICES

There exist many potential applications of bandwidth measurement methods. For example: streaming media adaptation, server selection, network tomography, TCP improvement and service-level-agreement verification. These are potential benefit that active measurements could give

4.1 Telemedicine Congestion Control and its Applications

The work in this paper is focused on applying ABETs to Telemedicine congestion control. We believe that telemedical applications may be of use in many, if not all, medical specialties. However this type of network facilitates learning through the exchange, transfer and distribution of medical information/knowledge, the generation and dissemination of new knowledge about how to collaborate effectively via telemedicine, and the application of this knowledge in telemedicine practice. Viewing telemedicine in this light directs our attention to outcomes not emphasized in most prior research, including the diffusion of medical knowledge and expertise, and the development of collaborative knowledge shared by the health care parties. In addition to documenting telemedical applications as solutions to specific local problems, successfully implemented telemedical applications

The telephone companies, has a standard interface consisting of a basic rate with dual 64-kbps voice/data channels and a T1 transmission primary rate of 1.544 Mbps. This rate is insufficient for the transfer of high-quality images, since, for instance, VHS-quality video requires about 1.2 Mbps and high-definition television up to 50 Mbps. The Switched Multimegabit Data Service (SMDS), which now operates at rates up to the T3 line rate of 44.736 Mbps, in available is some metropolitan areas and is expected to be accessible regionally in the near future. It is to be an OC-12 network with a line rate of 622.08 Mbps, which is equivalent to 2016 channels at 64 kbps. This capability will enable the Laboratory to carry out wideband communications to support its research in all areas, including telemedicine. Bandwidths of this order of magnitude are necessary for teleradiology and telepathology studies and research.

4.2 How ICTs bring about development

Telemedicine promises an improvement of health care service quality in rural, urban, dense and mobile areas. Telemedicine is an emerging technology which combining telecommunication and information technology for medical practice.

The majority of people across Africa live in rural/remote areas, which have minimal health services, lack providers, and experience inadequate access due to geography, weather, infrastructure and a range of other challenges. The healthcare facilities and their staff often operate in isolation. Simple training, protocol updates, and consultations are almost unheard of. In Tanzania, finances and geographic realities further challenge even meeting the basic health needs but the paucity of skilled health staff creates a further abyss. The first line care in rural areas is provided by Clinical Officers with 3 years medical training or Assistant Medical Officers with an additional 2 years medical training. There are few graduate Medical Officers and hardly any specialists in the rural hospitals. This leads to low level of diagnostic and treatment quality in a wide variety of health problems especially in the rural areas. The rapid advances in information technology and telecommunications and more specifically wireless,

mobile communications and optical fiber and their convergence are leading to the emergence of a new type of information infrastructure that has the potential of supporting an array of advanced services for healthcare. Increases timeliness of treatment and decreases transfer rates while reducing medical costs through video technology.

5 CONCLUSION

In this paper we have presented bandwidth measurement evaluation methods in both wired and wireless networks by using the IGI (Initial Gap Increasing) and the PTR (Packet Transmission rate). Several simulations have been carried out using MATLAB R2012b to determine the difference between wired and wireless networks available bandwidth. The results suggest that the wired network environment has more available bandwidth compared to wireless networks, hence the wired networks are the most appropriate method for telemedicine services. One can use the results obtained to select the most appropriate network bandwidth requirements depending on the ability of exchange multimedia data of an organization or country. The logistics could cater implementation of low cost for the telemedicine applications.

ACKNOWLEDGMENTS

We wish to thank the Nelson Mandela African Institute of Science and Technology (NM- AIST) and the School of Computation and Communication Science and Engineering (CoCSE) for supporting this work and for allowing us to use their resources.

REFERENCES

- [1] N. Hu and P. Steenkiste, "Evaluation and characterization of available bandwidth probing techniques," *Selected Areas in Communications, IEEE Journal on*, vol. 21, pp. 879-894, 2003.
- [2] M. Jain and C. Dovrolis, "Pathload: A measurement tool for end-to-end available bandwidth," in *Proceedings of Passive and Active Measurements (PAM) Workshop*, 2002.
- [3] V. J. Ribeiro, R. H. Riedi, R. G. Baraniuk, J. Navratil, and L. Cottrell, "pathchirp: Efficient available bandwidth estimation for network paths," 2003.
- [4] J. Strauss, D. Katabi, and F. Kaashoek, "A measurement study of available bandwidth estimation tools," in *Proceedings of the 3rd ACM SIGCOMM conference on Internet measurement*, 2003, pp. 39-44.
- [5] L. Palen, M. Salzman, and E. Youngs, "Going wireless: behavior & practice of new mobile phone users," in *Proceedings of the 2000 ACM conference on Computer supported cooperative work*, 2000, pp. 201-210.
- [6] E. Supriyanto, H. Satria, and E. Putra, "A novel low cost telemedicine system using wireless MESH network," 2009.
- [7] J. Curtis and T. McGregor, "Review of bandwidth estimation techniques," in *Proceedings of the New Zealand Computer Science Research Students' Conference*, 2001.
- [8] J. Navratil and R. L. Cottrell, "ABwE: A practical approach to available bandwidth estimation," in *Proceedings of the 4th Passive and Active Measurement Workshop PAM 2003*, 2003.
- [9] E. Goldoni and M. Schivi, "End-to-end available bandwidth estimation tools, an experimental comparison," in *Traffic Monitoring and Analysis*, ed: Springer, 2010, pp. 171-182.
- [10] A. F. Haque, M. H. Ali, and M. A. Kiber, "Bandwidth optimization of individual hop for robust data streaming on emergency medical application," *Journal of Engineering and Applied Sciences*, vol. 4, 2006.
- [11] V. Jacobson, "Pathchar: A tool to infer characteristics of Internet paths," ed, 1997.
- [12] A. B. Downey, "Using pathchar to estimate Internet link characteristics," in *ACM SIGCOMM Computer Communication Review*, 1999, pp. 241-250.
- [13] B. A. Mah, "pchar: A tool for measuring internet path characteristics," <http://www.kitchenlab.org/www/bmah/aSoftware/pchar/>, 2001.
- [14] A. Pásztor and D. Veitch, "The packet size dependence of packet pair like methods," in *Quality of Service, 2002. Tenth IEEE International Workshop on*, 2002, pp. 204-213.
- [15] C. Dovrolis, P. Ramanathan, and D. Moore, "What do packet dispersion techniques measure?," in *INFOCOM 2001. Twentieth Annual Joint Conference of the IEEE Computer and Communications Societies. Proceedings. IEEE*, 2001, pp. 905-914.
- [16] L. Rizzo, "Dumynet: a simple approach to the evaluation of network protocols," *ACM SIGCOMM Computer Communication Review*, vol. 27, pp. 31-41, 1997.
- [17] G. F. Lucio, M. Paredes-Farrera, E. Jammeh, M. Fleury, and M. J. Reed, "Opnet modeler and ns-2: Comparing the accuracy of network simulators for packet-level analysis using a network testbed," *WSEAS Transactions on Computers*, vol. 2, pp. 700-707, 2003.